

227.5X80T2 | 113A.SR - Clés à molette ADF

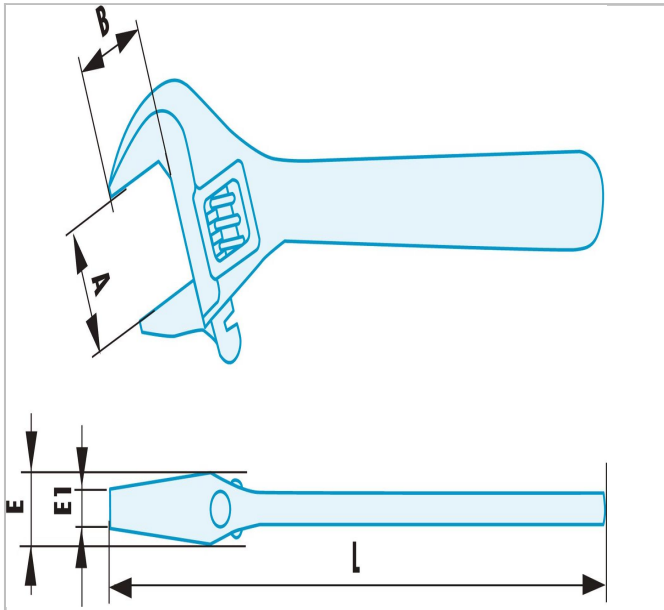

Description :

- Alliage spécial Cuivre-Béryllium antidéflagrant et antimagnétique.





227.5X80T2