

227.14X200T3 | 113A.SR - Clés à molette ADF

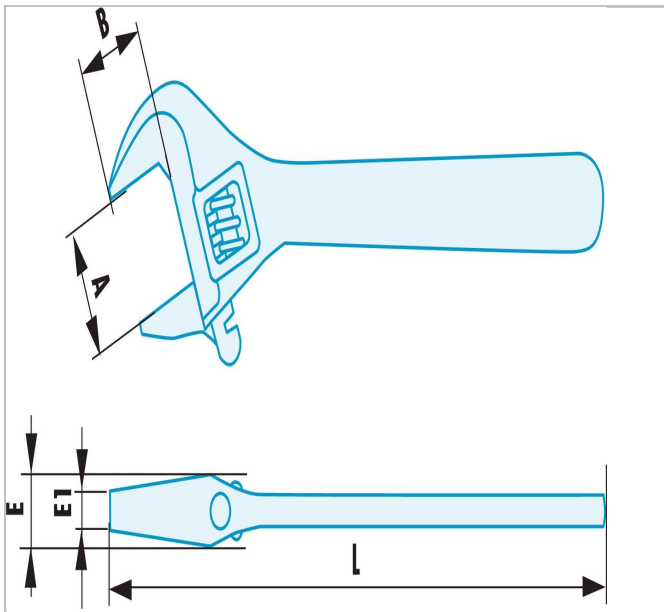

Description :

- Alliage spécial Cuivre-Béryllium antidéflagrant et antimagnétique.





227.14X200T3