

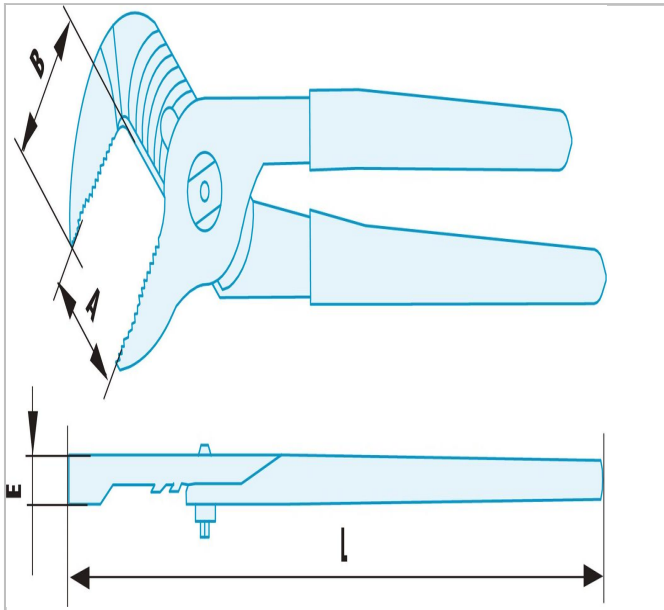

## 482.30SR | 482.SR - Non sparking multigrip pliers



### Description:

- Special non sparking and anti-magnetic Copper-Beryllium alloy.
- For safety purposes, FACOM uses sheaths in overmoulded antistatic pvc to prevent any risk of sparks.



	482.30SR
A [mm]	55.0
Length L [mm]	300.0
Thickness E [mm]	11.0
Head Width B [mm]	38.0
Weight [g]	745.0