

E200529 | 289.M - Casse-écrous

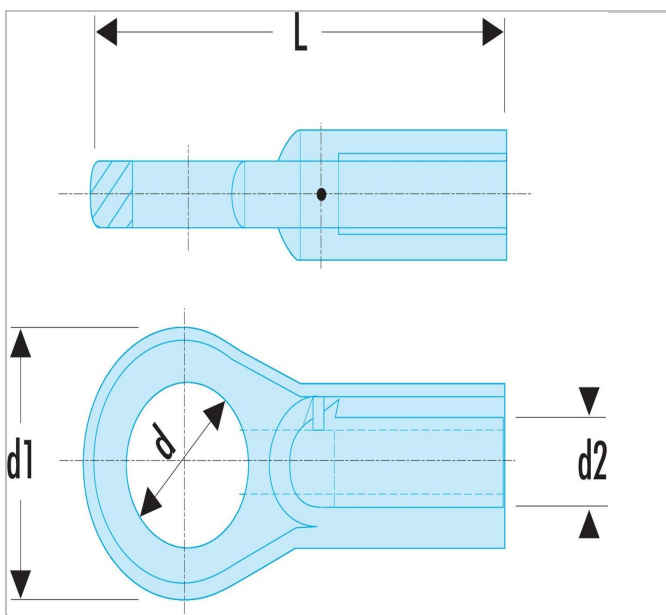

Description :

- Permet de casser un écrou arrondi ou bloqué sans abîmer la tige filetée.





E200529