

## E020304 | 440.SR - Clés mixtes métriques ADF

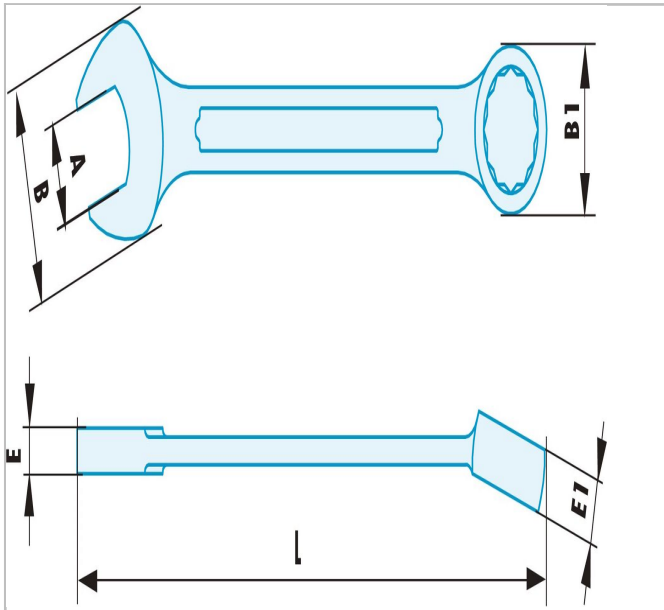

### Description :

- Alliage spécial Cuivre-Béryllium antidéflagrant et antimagnétique.





E020304