

E113589 | 440.SR - Clés mixtes métriques ADF

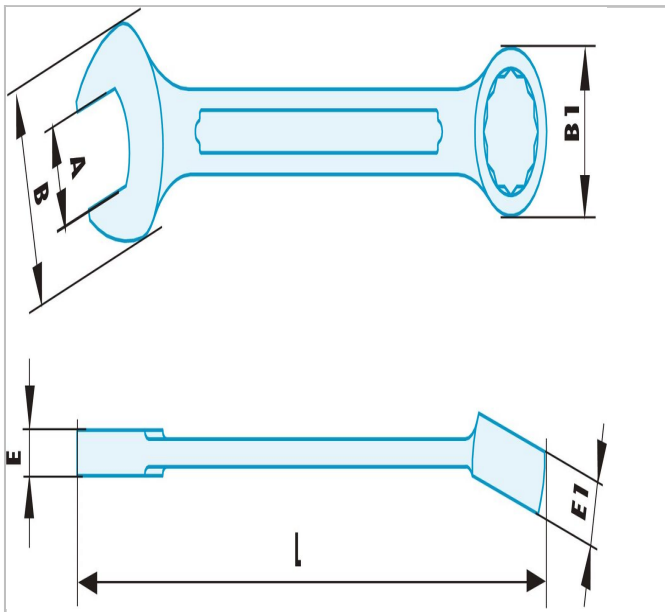

Description :

- Alliage spécial Cuivre-Béryllium antidéflagrant et antimagnétique.





E113589