

## E113600 | 440.SR - Clés mixtes métriques ADF

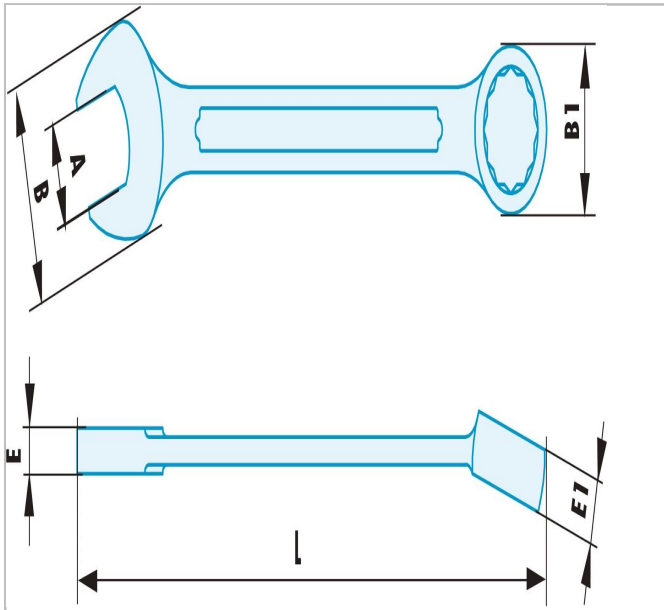

### Description :

- Alliage spécial Cuivre-Béryllium antidéflagrant et antimagnétique.





E113600