

467B.3/8 | 50.SR - Clés polygonales à frapper métriques ADF

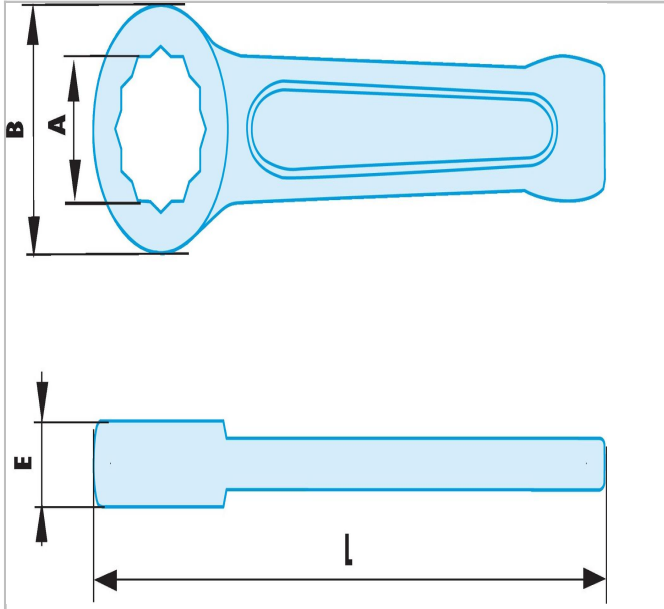

Description :

- Alliage spécial Cuivre-Béryllium antidéflagrant et antimagnétique.





467B.3/8