

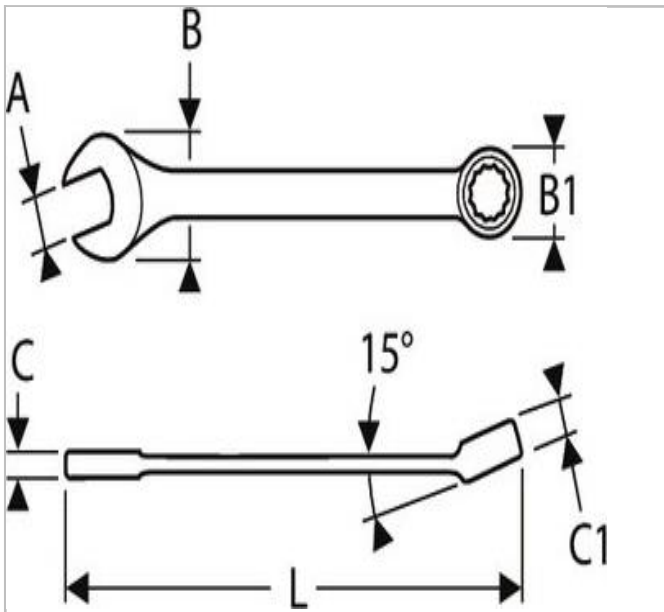

E113226 | EXPERT Combination wrenches - Metric



Description:

- ISO 691
- ISO 1711-1
- ISO 3318
- ISO 7738
- DIN 3113
- 12-point OGV® ring angled at 15°.
- Open end angled at 15° from handle axis.
- OGV® profile maximizing the contact surface with the nut for a longer lifetime.
- Forged in Chrome Vanadium steel.
- High chrome finish.



	E113226
A [mm]	32
Length L [mm]	360.0
Thickness E1 [mm]	10.6
Thickness E2 [mm]	16.9
Head Width B [mm]	64.7
Head Width B1 [mm]	47.3
Weight [Kg]	0.6
Head Height C [mm]	10,6
Head Height C1 [mm]	16.0