

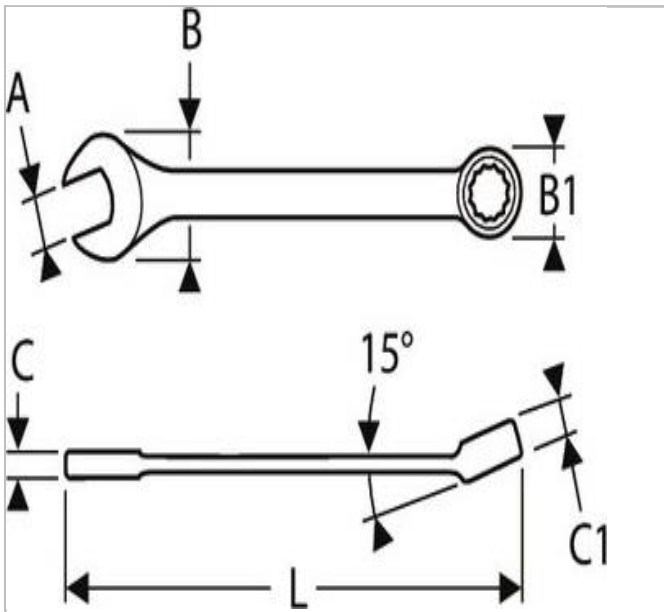

E113217 | EXPERT Combination wrenches - Metric



Description:

- ISO 691
- ISO 1711-1
- ISO 3318
- ISO 7738
- DIN 3113
- 12-point OGV® ring angled at 15°.
- Open end angled at 15° from handle axis.
- OGV® profile maximizing the contact surface with the nut for a longer lifetime.
- Forged in Chrome Vanadium steel.
- High chrome finish.



	E113217
A [mm]	22
Length L [mm]	260.0
Thickness E1 [mm]	8.0
Thickness E2 [mm]	11.9
Head Width B [mm]	48.7
Head Width B1 [mm]	33.0
Weight [Kg]	0.242
Head Height C [mm]	8
Head Height C1 [mm]	11.9