

E117822 | 50.SR - Clés polygonales à frapper métriques ADF

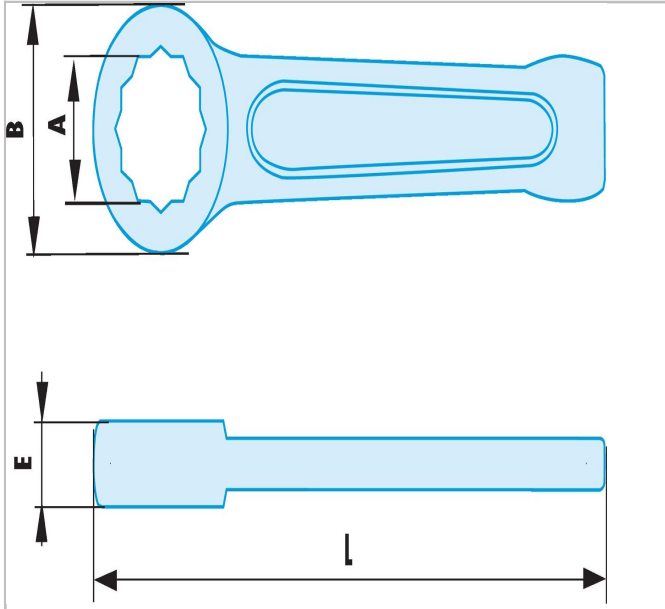

Description :

- Alliage spécial Cuivre-Béryllium antidéflagrant et antimagnétique.





E117822